

# AudioControl®

Making Good Sound Great™



## The Director™ Model M6800D

16-CHANNEL MULTI-ZONE NETWORK MATRIX AMPLIFIER  
WITH BUILT-IN DANTE PORT

# Important Safety Instructions

1. Read these instructions.
2. Keep these instructions.
3. Reading the instructions should take less time than a Peter Jackson Trilogy.
4. Do not use this apparatus near water.
5. Clean only with a dry cloth.
6. Do not block any ventilation openings. Install in accordance with the manufacturer's instructions.
7. Do not install near any heat sources such as radiators, heat registers, stoves, or other apparatus (including amplifiers) that produce heat.
8. Protect the power cord from being walked on or pinched particularly at plugs, convenience receptacles, and the point where they exit from the apparatus.
9. Only use attachments/accessories specified by the manufacturer.
10. Unplug this apparatus during lightning storms or when unused for long periods of time.
11. Refer all servicing to qualified service personnel. Servicing is required when the apparatus has been damaged in any way, such as power-supply cord or plug is damaged, liquid has been spilled or objects have fallen into the apparatus, the apparatus has been exposed to rain or moisture, does not operate normally, or has been dropped.
12. This apparatus shall not be exposed to dripping or splashing, and no object filled with liquids, such as vases or glasses, shall be placed on the apparatus.



The lightning flash with arrowhead symbol within an equilateral triangle is intended to alert the user to the presence of uninsulated "dangerous voltage" within the product's enclosure, that may be of sufficient magnitude to constitute a risk of electric shock to persons.



The exclamation point within an equilateral triangle is intended to alert the user of the presence of important operating and maintenance (servicing) instructions in the literature accompanying the appliance.

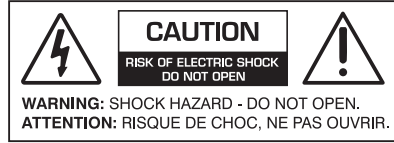

Caution: to reduce the risk of electric shock, do not remove the top cover. There are no user-serviceable parts inside. Refer servicing to qualified personnel.

This equipment has been tested and found to comply with the limits for a Class B digital device, pursuant to part 15 of the FCC Rules.

These limits are designed to provide reasonable protection against harmful interference in a residential installation.

This equipment generates, uses, and can radiate radio frequency energy and, if not installed and used in accordance with the instructions, may cause harmful interference to radio communications. However, there is no guarantee that interference will not occur in a particular installation.

If this equipment does cause harmful interference to radio or television reception, which can be determined by turning the equipment off and on, the user is encouraged to try to correct the interference by one or more of the following measures:

- Reorient or relocate the receiving antenna.
- Increase the separation between the equipment and the receiver.
- Connect the equipment into an outlet on a circuit different from that to which the receiver is connected.
- Consult the dealer or an experienced radio/TV technician for help.

**CAUTION:** Changes or modifications to this device not expressly approved by AudioControl Inc. could void the user's authority to operate the equipment under FCC rules.



Recycling notice: If the time comes and this apparatus has fulfilled its destiny, do not throw it out into the trash. It has to be carefully recycled for the good of mankind, by a facility specially equipped for the safe recycling of electronic apparatus. Please contact your local or state recycling leaders for assistance in locating a suitable nearby recycling facility. Or, contact us and we might be able to repair it for you.

# Table of Contents

<b>Important Safety Instructions</b> .....	2
<b>Introduction</b> .....	4
Congratulations! .....	5
Features .....	6
Complimentary Features .....	8
QuickView .....	9
<b>Getting Started</b> .....	10
Installation Examples .....	11
Front Panel Features .....	14
LED Function Table .....	15
Rear Panel Features .....	16
<b>Zone Section</b> .....	19
Speaker and Wiring Impedance .....	20
12 Volt Trigger Ins and Outs .....	21
Ventilation .....	23
<b>Internet Connectivity and Control</b> .....	24
<b>Web Interface</b> .....	27
<b>Zone Settings and Options</b> .....	29
Speakers .....	32
X-Over .....	33
EQ .....	34
<b>Global Settings</b> .....	36
Signal Decting Switching .....	38
<b>Dante Configuration</b> .....	40
<b>Acoustics</b> .....	41
<b>Equalization</b> .....	42
<b>Advanced Discussions</b> .....	45
<b>Troubleshooting</b> .....	47
<b>Block Diagram</b> .....	49
<b>Specifications</b> .....	50
<b>Service</b> .....	51
<b>The Warranty</b> .....	52
<b>Installation Notes</b> .....	54
<b>Dante Boogie</b> .....	56

Network Settings	
Default IP Address	<b>192.168.0.249</b>

**THE DIRECTOR™**  
Model M6800D

# Introduction

Modern whole-house audio systems command high levels of musical performance, but contemporary architectural restraints often limit necessary installation space. The AudioControl Director M6800D was created to provide the ideal solution when wide-bandwidth, authoritative amplification is required in a compact footprint.

Generating a minimum of 100 Watts per channel into 8 Ohms, and a staggering 200 Watts per channel into 4 Ohms, with all 16 channels actively driven, the M6800D is the first Director Series AudioControl network DSP matrix amplifier to incorporate Dante audio networking.

When matched with capable, aesthetically discreet speakers, the M6800D delivers clean, dynamic high power that excavates subtle nuanced musical complexities at any listening level, particularly lower to medium volume settings. Precisely controlled power tracking, a benchmark of AudioControl's Class D amplifier designs, delivers transients with unparalleled

clarity and adequate headroom to unmask intricate details and elevate music's emotional impact, that otherwise, appears forced and smeared indistinctly together when adequate drive power is lacking.

The AudioControl Director M6800D is where intuitive meets protective. Each high-powered channel is individually monitored by logically optimized, hyper-fast built-in protection features, safely preventing thermal or short-circuit harm to amplifier output devices, and power-related damage to in-wall, in-ceiling, or visually concealed behind-wall speaker systems. DC offset protection isolates smaller speaker woofers from non-linearities that can induce unwanted distortion, while intelligent bandpass filtering and our exclusive anti-clipping circuitry, LightDrive, prevent ultrasonic signals from destroying delicate tweeters. Calibration profiles for AudioControl Sound Partners™, included in M6800D software, provide equalization curves and crossover points designed to unlock peak performance from these select speaker models.

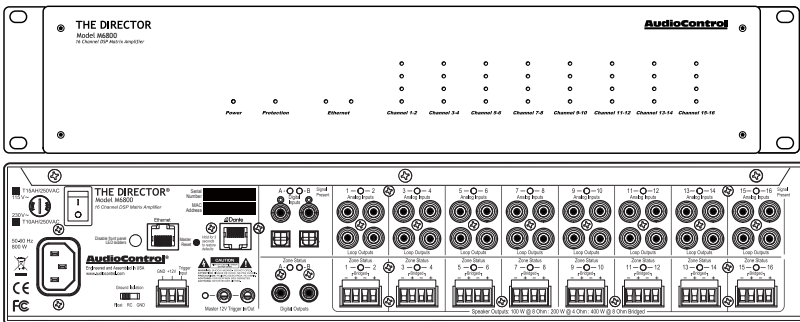

# Congratulations

You are about to install a high-powered, performance-oriented, audio amplifier engineered to dramatically enhance the sound quality of distributed audio systems for any application. Designed to meet the needs of every integrator's wish list, the Director M6800 is a 16-channel, network-controlled, switched matrix input amplifier capable of high output power levels, and featuring Dante Audio support, precision-crafted by AudioControl in America's Pacific Northwest.

Key features of the Director M6800D include DSP processing for onboard equalization, adjustable interzone delay times, selection of crossover points, and output level functionality. All parameters are controllable via Ethernet, enabling refinements to be made remotely, or simply on-site as "set and forget". A hallmark of all Director series components is unfailing reliability for a lifetime of trouble-free service, by the only global audio electronics company specializing in high-powered amplifiers with built-in digital graphic and parametric equalization, plus comprehensive signal processing.

Driving this passion for high quality and meticulous attention to detail is our Pro Audio heritage, proudly displayed in the dozens of industry awards won by our designs, products, and service. When we began, the greatest satisfaction was people throughout the world, just like you, discovering our reputation for sonic excellence and reliability, which remains steadfast today.

This manual is aimed at professional installers or knowledgeable end users and is designed to help fully utilize the M6800D's capabilities and tailor them for superb audio quality. A presumption is made that experience with multi-channel amplifiers and Ethernet protocol is in hand. To perform initial setup or make operational adjustments, the unit requires connection to a network for Ethernet and Dante.

## Features

The features below make the M6800D unique, placing it in a class by itself from other multi-zone amplifiers.

- **Digital and Analog Input Matrixing**

Each zone may select and play any digital or analog input. Digital inputs are high-resolution and accept 32-96 kHz, 16- to 24-bit digital signals. Each zone has a pair of single-ended, RCA-type connectors as an analog output loop to pass that zone's audio signal to an additional Director unit. The digital outputs can also pass through any analog or digital input source.

- **High Power Levels**

The M6800D has 16 channels, 100 Watts per channel into 8 Ohms, or 200 Watts into 4 Ohms, all channels actively driven. Each channel pair may optionally be bridged for mono operation (8 Ohms minimum impedance). All amplification modules are a discrete component design for rugged, long-term operational service, and optimal audio performance.

- **Superior Sound Quality**

Audio fidelity is the first criterion in all AudioControl designs, uncompromised by any other feature.

- **Intelligent Power Supply for Unparalleled Energy Efficiency**

In today's eco-sensitive world, energy conservation is important to end-users and has become a major consideration in system design. Unequaled in its class for energy efficiency, AudioControl Class D amplifier technology at the core of the Director M6800D output topology provides optimum signal headroom under any load, while drawing substantially less AC power than traditional multi-zone amplifiers when in operation. At idle, the M6800D requires only 2 Watts to maintain standby readiness.

- **LightDrive Anti-clipping**

The M6800D is equipped with the latest evolution of AudioControl's LightDrive anti-clipping protection. During operation, LightDrive monitors power supply demand from all amplifier channels. When the speaker output of a channel attempts to draw more voltage than what is available from the power supply, LightDrive intelligently determines what the wave-peak point is and prevents the amplifier from reaching that plateau by applying high-frequency gain compression to the output signal and reducing the high-frequency volume level until the audio waveform returns to its linear state. In all but the most severe instances, this measure of protection is instantaneous with no audible drawbacks.

- **Ethernet Control**

The M6800D can be controlled remotely via a browser or by using Telnet commands. Functions such as zone muting, line voltage, and protection log display can be queried, and even source inputs may be changed or EQ presets may be recalled.

- **Signal Processing**

Digital signal processing provides convenient, software-directed setup and control for most M6800D operational sound-shaping parameters. Broad graphic equalization or more precise parametric equalization settings may be ganged, with left and right channels together or adjusted separately, combined with six lockable EQ presets per zone, recallable via the browser. Filters for tweeter protection and low-frequency cutoff are also browser-controlled. Any zone may be configured with low-pass and high-pass channels for specific speaker requirements.

- **Auto-resetting Protection Features**

Extensive built-in protection features include thermal monitoring and shut-off, short circuit detection, LightDrive anti-clipping with ultrasonic protection, and DC offset isolation, to name a few. Once a fault is removed, the Director M6800D will reset and resume operation.

- **Dante Audio**

M6800D is the first Director Series network amplifier with a Dante port for connectivity and data exchange with other Dante-equipped devices using a single CAT5e or CAT6 cable. Dante enables the DM6800D to share high-resolution audio with AudioControl CM Series amplifiers plus other equipment with Dante capabilities.

- **Pacific Northwest Heritage**

This product is proudly manufactured in the USA. More important is the care taken at each skillfully crafted step of the process, along with the extensive knowledge that the entire AudioControl staff has in every aspect of its design and performance capabilities. The M6800D is backed by a conditional, five-year warranty.

## Complimentary Features

- **DHCP**

An IP address is secured via DHCP by default when the Director M6800D is connected to a network. If a DHCP server is not found, the Director M6800D will default to **192.168.0.249**.

- **UPnP**

Device discovery is enabled on The Director M6800D for ease of connectivity to a PC.

- **Numbering**

In the device discovery/UPnP window, multiple Director amplifiers are numbered in the sequence they were added to the network.

- **Groups**

Grouping has been enabled for quick control of zones through Telnet commands. Up to 8 groups can be defined for control over Standby and Source Selection.

- **Export/Import**

Exporting and importing amplifier settings, including EQ settings, are enabled. EQ settings may be configured as a template and applied to all Director M6800D amplifiers in a system. This provides a starting point from which additional refinements may be made.

- **Dante**

16x16 Dante input/output matrixing and system integration with additional M6800D and AudioControl CM series amplifiers, as well as integration into third-party over-control systems.

- 16 channels of high-powered Class D amplification
- Matrixable Inputs - Any zone is able to play any input source
- Efficient amplifier modules and power supply
- Power consumption of less than 2 Watts when in standby mode
- Rack mountable 2U form factor
- Removable rack adapters
- Lightweight, rack-mountable, 2U compact chassis
- Did you do something special with your hair today, You look excellent!
- Stackable with other Director, Architect, or CM Models
- Signal sense independent for each zone
- Input assignment independent for each zone
- Buttery Signal Processing allows for a wide variety of EQ options and adjustments
- 12V Master trigger usable with contact closure or 12V external source
- A and B digital inputs assignable to any zone
- A and B digital outputs assignable from any analog or digital input
- Analog RCA loop-through outputs
- And the empty box makes a great home for small to medium sized pets like cats, gerbils or komodo dragons



# Quick View

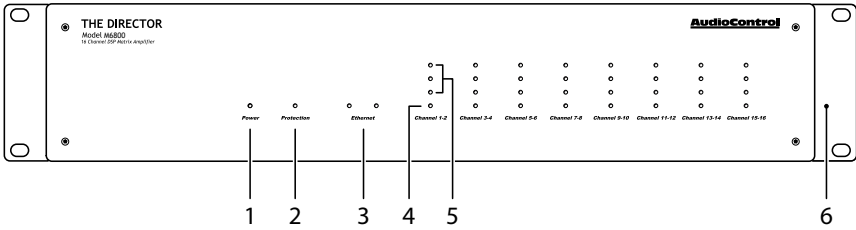

## Front Panel

1. Power LED
2. Protection LED
3. Ethernet Status LEDs
4. Zone Status LED
5. Zone Level LED Ladder
6. Rack Mount Ears

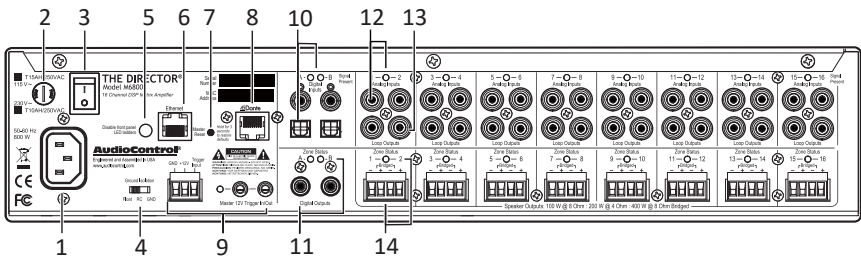

## Rear Panel

1. AC Input
2. AC Fuse
3. AC Power Switch
4. Ground Isolation Switch
5. Disable Front Led Ladders
6. Ethernet Port
7. Master Reset Button
8. Dante Port
9. Master Trigger
10. Digital Coaxial and Optical Inputs A/B and LEDs
11. Digital Coaxial Outputs A/B and LEDs
12. Analog RCA Line Level Inputs and LEDs
13. Loop Outputs
14. Speaker Outputs and Zone Status LEDs

THE DIRECTOR™  
Model M6800D

Installation Manual

# Getting Started

1.  Power off all components before making any connections.
2. When making connections, confirm RCA cabling maintains Right and Left status for all analog audio system connections. This will reduce potential connection issues.
3. Whenever possible, isolate power cords from signal cabling to prevent ground-induced hum. Bundle cables as same-type, do not mix.
4. Use high-quality interconnect cables. Inexpensive cables do not fare well in an elevated temperature rack environment, breaking down over time to create signal loss or hum. Typically, they are badly shielded with poorly fitting RCA connectors.
5. For analog cable runs in excess of 20 feet, consider using a transmitter-receiver extension kit that is capable of delivering audio noise-free over Category cabling. Some kits can convert 3D immersive soundtracks into two-channel stereo for site-wide distribution and intelligible listening.
6. When using the A or B coaxial (RCA) digital inputs, use high-quality cables with the correct impedance designed for digital audio use. Proper RCA-type digital audio cables are 75 Ohms impedance, with both the center conductors and the shielding crimped, not soldered, to the RCA connector to maintain 75 Ohm impedance. A cable designed for digital audio will also be capable of handling the high frequencies that comprise a digital signal. For these reasons, do not substitute analog audio cables for digital audio cables.
7. Connect an Ethernet cable from the RJ45 Ethernet Port on The Director M6800D to the network.
8. Open your browser and open the Web Interface within the unit. All controls and features of the unit will be displayed.
9. Enter the Matrix and Consult the Oracle to find out what is next Neo.

## Installation Examples

The following pages show typical installation scenarios for The Director M6800D with associated AudioControl components.

# Installation with multiple M6800D amplifiers

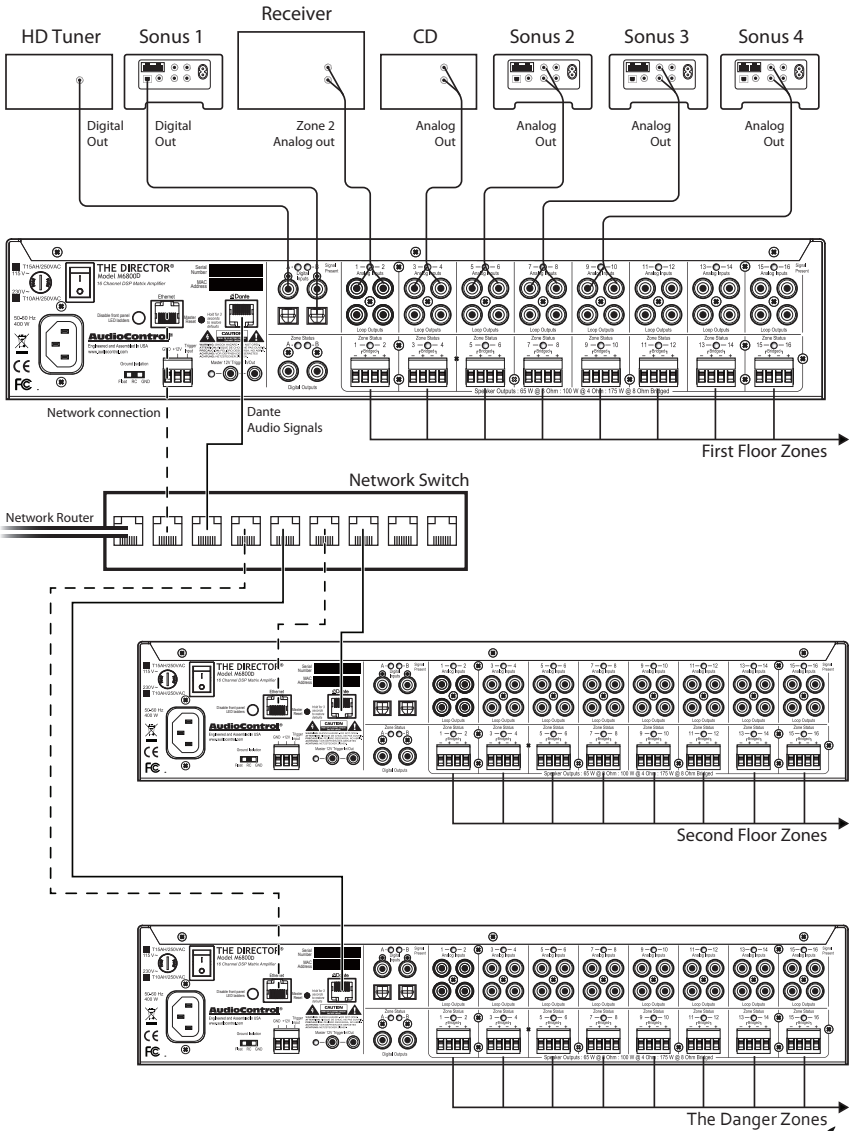

THE DIRECTOR™

Model M6800D

Installation Manual

# Installation with an Architect 2660

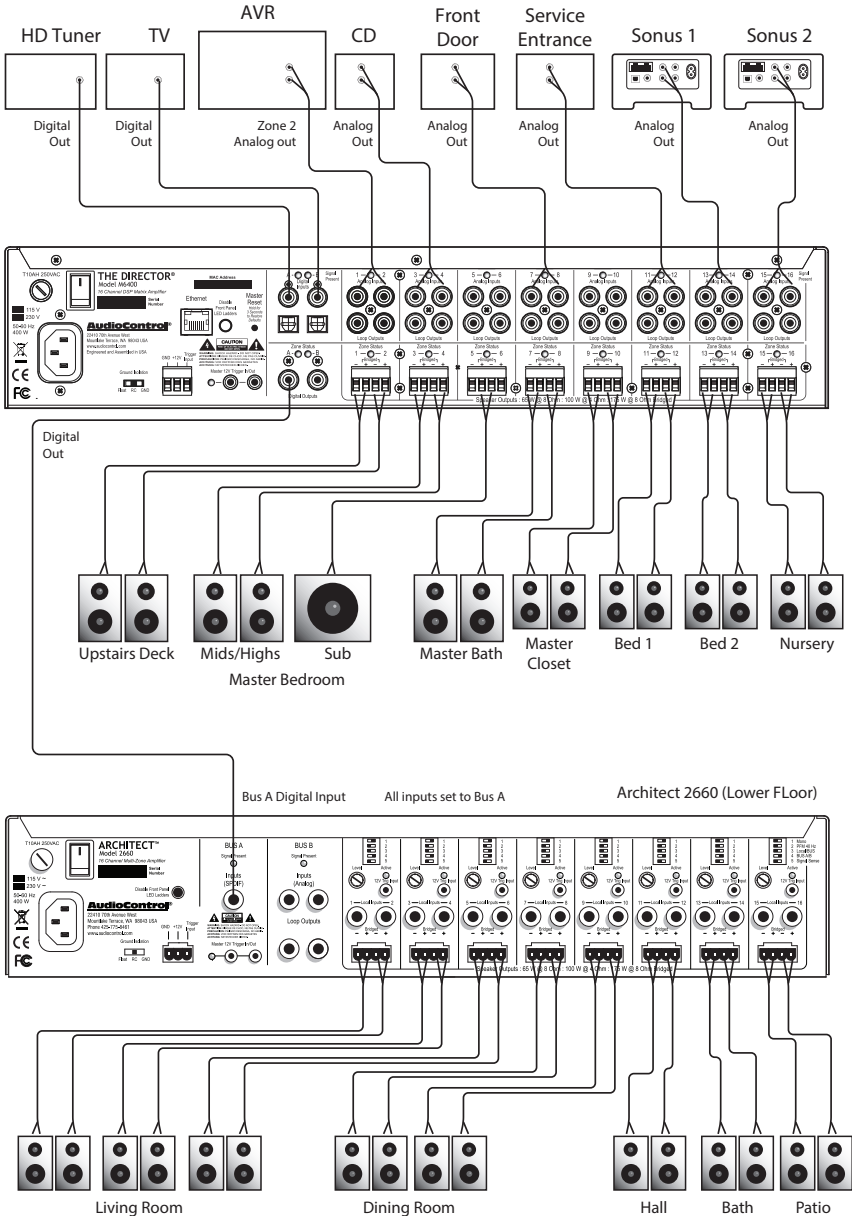

# Installation with one Bijou 600 Amplifier

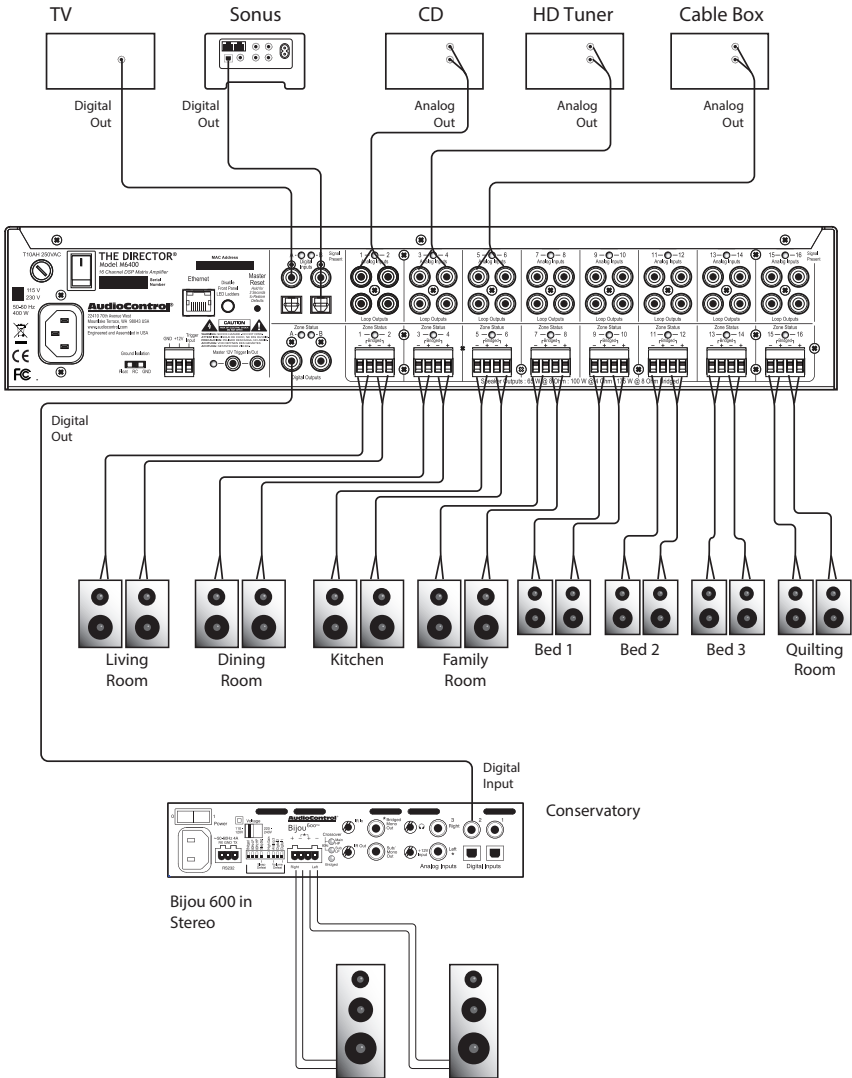

THE DIRECTOR™

Model M6800D

Installation Manual

# Front Panel Features

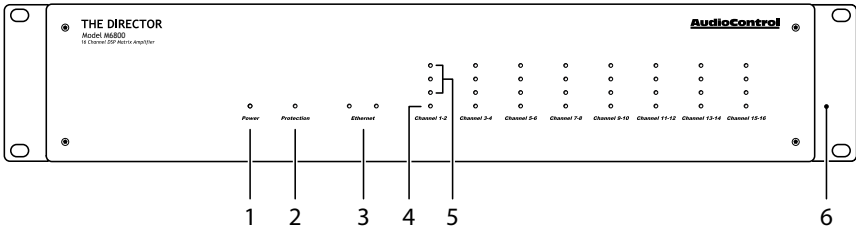

## 1. Power LED

This dual-color LED indicates when the unit is in standby, on, or off

**Red:** The unit is in standby mode and is ready to be turned on via Ethernet or 12V triggering

**Blue:** The unit is on

**Green:** Kermit thinks you're doing a great job

**OFF:** The unit is powered off

## 2. Protection LED

This red LED will illuminate briefly during the turn-on/off phases. During operation, when a fault is detected in an amplifier channel or in the power supply (a fault might be thermal-related, excessive current draw, or DC offset) these lights will illuminate. A fault may cause the unit to enter the protection mode to prevent damage to internal circuitry and all connected loudspeakers. If the fault is thermal-related, the unit will require time for cooling before normal operation may resume.

## 3. Ethernet LEDs

Two LEDs indicate connectivity status and data activity.

**Green:** Illuminates when connected to a network and operational.

**Yellow:** Blinks to reflect data transmission

## 4. Zone Status LED

This dual-color LED indicates when the zone is active, in standby, or if a fault has occurred.

**Red:** A fault is detected in the zone amplifier module, such as excessive DC offset, or a load short circuit

**Blue:** The zone status is active

**OFF:** The zone status is standby

## 5. Zone Level LEDs

From the bottom up, three LEDs illustrate zone output level status incrementally (-33, -20, -10 dBFS). They may be turned off using the rear panel switch labeled Disable Front Panel LED Ladders.





## 6. Rack Mount Ears

Supplied with the unit are adapter ears to accommodate standard 19" wide mounting, with a 2RU height. Use standard rack screws and ground-isolating shoulder washers to secure the unit inside a rack. Rear support is not required in fixed locations. To remove the rack ears, remove the power cord from the unit. Each ear is secured to the chassis by four screws. Undo only these screws and retain them, then remove the ears. Replace the screws securely into the chassis. Never remove any chassis or top cover screws. Inside the chassis are lethal voltages. Retain the rack ears for future use.

**AudioControl®**

Making Good Sound Great™

## LED Function Table

LED	Color	Description
 <b>Power</b>	Red	The unit is in standby mode
	Blue	The unit is on
	Off	The unit is powered off
 <b>Protection</b>	Red	The unit has detected a fault and is in protect mode*
	Off	The unit is operating normally, or it is powered off
ZONE LEDs	Color	Description
 	Blue	-10 dBFS zone output level
	Blue	-20 dBFS zone output level
	Blue	-33 dBFS zone output level
 <b>Channel 1-2</b>	Red	The zone has detected a fault, and is in protect mode
	Blue	The zone is active
	Off	The zone is in standby

\*The protection LED also comes on for a short time during power up or down

# Rear Panel Features

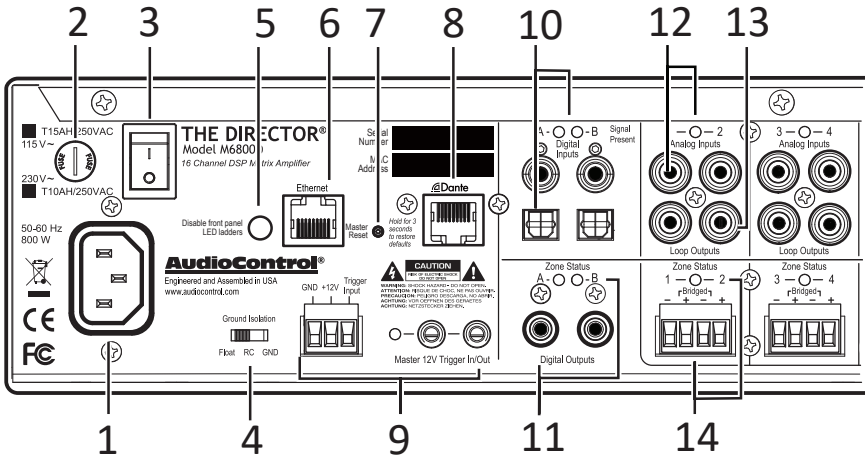

## AC section



When rack-mounting the unit, make sure that the power cord and the AC power switch remain readily accessible.

### 1. AC Input

Connect the supplied AC power cord securely to this input. Plug the other end into an AC mains outlet of the correct voltage rating for your unit. They are either 100 -120 VAC (50 – 60 Hz) or 220 – 240 VAC (50 – 60 Hz). A checked box designates the unit configuration and it is not user-settable.

### 2. AC Fuse

The main power supply fuse may be checked or replaced. Before attempting to undo the fuse carrier from the holder, remove the power cord from the AC mains. The carrier may be backed out of the holder by carefully placing the tip of a flat-head screwdriver into the slot on the carrier, and slowly turning anti-clockwise.

### 3. AC Power Switch

This switch shuts off the main AC power. This may only be required to be turned off when the system will be shut down for an extended period of time. Operational Ethernet commands or the master trigger inputs are used for switching the unit between standby and on.



#### 4. Ground Isolation Switch

This switch selects the level of isolation between the audio signal ground and the AC earth ground. The factory default position is GND and should be used during regular operation. Two other settings are available to combat AC mains noise. The RC (Resistor Capacitor) setting is designed to address high-frequency noise. High-frequency noise components see the capacitor's connection to ground and follow this low-impedance path. The FLOAT setting is effective in eliminating ground loops. For safety, the chassis is always connected to the earth's ground regardless of the switch setting. NEVER use three-prong/two-prong adapters, commonly called 'cheater plugs', to connect this unit to a NEMA 1-15R non-grounding receptacle. These are seldom used as intended, with the grounding tab attached to the outlet faceplate screw, which itself should be connected to the electrical ground. A fault can send high current through the chassis, all connected cables, and outward. This unit is a class 1 device, NEVER remove the grounding lug from a NEMA 5-15P power cord for use in a two-prong NEMA 1-15R non-grounding receptacle. NEMA 5-15P plugs rely on the grounding pin for proper orientation. Removal risks insertion into the outlet with neutral and hot wires reversed, creating an additional hazard.

#### 5. Disable Front Panel LED Ladders

The front panel LED ladders indicate output levels in active zones. To disable the display, depress this switch. (Do this instead of cutting the red wire). Power, Protection or Zone Status LEDs will remain functioning.

#### 6. Ethernet LAN Port

This port connects The M6800D to a 10BaseT network via CAT5e-CAT6 cabling, enabling control by the internal Web Interface, accessible through a standard web browser. The M6800D does not require internal software for operation. See the section on Internet Connectivity and Control for detailed information.

#### 7. Master Reset

Should the M6800D fail to communicate, pressing and holding this button for more than 3 seconds performs a reset of the internal Ethernet settings. WARNING: Never perform this function while turning on the AC power switch. All flash memory will be erased. If this has occurred, contact technical support for the latest firmware file.

#### 8. Dante Port

Connecting this RJ45 port to a network switch supporting Dante audio streams allows the Director to decode network information into uncompressed audio signals. Now that you have heard this information this message will self-destruct in 10, 9, 8, 7, 6.....

**THE DIRECTOR™**

Model M6800D

Installation Manual

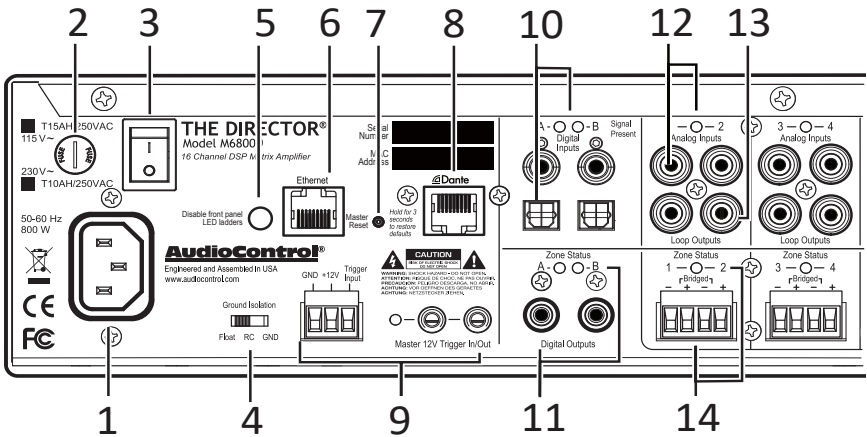

## 9. Master Trigger

There are three methods to turn on the unit or to place it into standby mode: via Ethernet, the TS 1/8" mono Master 12V Trigger input jacks, and the 3-pin block connector. AudioControl products with 12V trigger outputs may be used to pass on trigger commands to The Director M6800D when they power on, and the 12V master trigger out on this unit will do likewise. If Ethernet is not used to power on the M6800D and no trigger voltage is present at any trigger input, the unit will be in standby mode and all zones will be muted. To the left of the master 12V trigger in/out jacks is an LED indicator that will illuminate blue when this input is active, and off when no voltage is being applied. See Page 21 for more information on triggering details.

## Digital Inputs/Outputs

### 10. Digital Inputs

A and B digital inputs are RCA S/PDIF coaxial and TOSLINK optical. Digital signal data inputs directly into the

M6800D advanced DSP section for processing and is then made available to any or all zones, selectable using the M6800D web page interface. The Signal Present LEDs illuminate when a digital signal is present at the A or B inputs. As mentioned previously, use RCA-type cables designed for the impedance and high-frequencies of digital audio.

### 11. Digital Outputs

These S/PDIF digital outputs use standard 75 Ohm RCA coaxial connectors.

Digital signals from each of these outputs can be copied from any zone's input pair, (converted internally from analog to digital), or copied from the A or B digital inputs. These options are selectable using the M6800D web page interface. As an example, a copied output may be passed to additional M6800D, Architect, CM, Director, or Rialto series amplifiers. A Zone Status LED will illuminate to signify the digital output is active.

## Zone Section

(All details are the same for each zone)

### 12. Analog Inputs

These are line-level, single-ended, RCA analog inputs for legacy sources such as CD players, tape machines, or stand-alone AM/FM tuners. Using the M6800D web page interface menus, any zone may be configured for play as zone-specific, in mixed zones, or all zones simultaneously. No man to man coverage here. Additionally, these signals are also made available to the digital outputs for unparallelled flexibility. The LED illuminates when an analog signal is detected at the input.

### 13. Loop Outputs

Analog signals from the inputs above are directly looped through these line-level analog RCA outputs to additional M6800D, Architect, CM, Director, or Rialto series amplifiers.

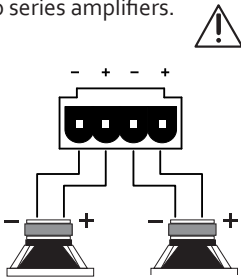

## Speaker Connections

### 14. Speaker Outputs

This 4-pin connector allows easy connection of two speakers for stereo operation, or one speaker for bridged mono operation.

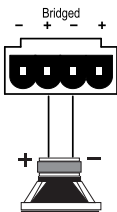

### Stereo Speaker Connection

 Note the polarity markings for each pair of outputs.

The speaker impedance should be 4 Ohms minimum in stereo operation.

### Bridged Mono Speaker Connection

Note the polarity markings of the inner pair of connections. In this mode, the input signals are combined in mono, and the power from both channels is combined to drive a single, more powerful, speaker.

The speaker impedance should be 8 Ohms minimum in bridged mono operation.

To set the output to be in mono, use The Director's Web Interface Operation menu (the first page that shows up) and click on the Mono box for this zone.

### Speaker Wiring

Establish a standard speaker wire color connection code and maintain it. It is important to match amplifier polarity (+ / -) with speaker polarity. On any speaker where the polarity may become reversed, that speaker will be out of phase with its paired partner, and from all other speakers in the same listening area. Bass response is impacted, with woofers that are out-of-phase working to cancel low-frequency sound waves produced by the speakers in phase.

See the next page for some handy information about speaker and wiring impedance.

**THE DIRECTOR™**  
Model M6800D

Installation Manual

## Speaker and Wiring Impedance

Speakers, like other resistors, when wired in parallel “show” lower values than the individual components. Here are two examples for calculating speakers wired in parallel:

### Calculating Impedance

For three 8 Ohm speakers wired in parallel (pluses connected to pluses) the impedance is  $1/8 + 1/8 + 1/8 = 3/8$   
Then take the inverse or  $8/3 = 2.66 \Omega$

For two 8 Ohm speakers wired in parallel (pluses connected to pluses) the impedance is  $1/8 + 1/8 = 2/8$   
Then take the inverse or  $8/2 = 4 \Omega$

Often the real world is more complicated than theory, and for speakers this is the case. An eight Ohm speaker is not eight Ohms at all frequencies. Plus passive crossover networks add their own changing conditions. Be aware of speakers that have significant dips from “nominal”

values in portions of their frequency range, and speakers that are rated at unusual impedances, for example, 3.5 Ohms.

The Director M6800D is tolerant of lower impedance loads, and as a properly designed amplifier allows for some leeway with impedance loading.

Speaker wire gauge combined with the length of the run also contribute to the speaker impedance load presented to any amplifier. As you can see in the table below, even fairly short speaker runs develop significant resistance when smaller wire gauges are used. This can be a benefit when a number of speakers are wired in parallel. The wire itself acts as an impedance limiter, since the amplifier cannot see a speaker load lower than the resistance of the wire. The downside to this form of wire resistance is that a portion of the total available power to the speakers is wasted.

## Speaker Wire Resistance:

### Wire Gauge versus Run Length

Wire Gauge	Run Length				
	25'	50'	100'	250'	500'
24 GA	1.3Ω	2.6Ω	5.1Ω	12.8Ω	25.7Ω
22 GA	0.8Ω	1.6Ω	3.2Ω	8.1Ω	16.0Ω
20 GA	0.5Ω	1.0Ω	2.0Ω	5.0Ω	10.1Ω
18 GA	0.3Ω	0.6Ω	1.2Ω	3.2Ω	6.4Ω
16 GA	0.2Ω	0.4Ω	0.8Ω	2.0Ω	4.0Ω
14 GA	0.1Ω	0.25Ω	0.5Ω	1.26Ω	2.5Ω
12 GA	0.08Ω	0.16Ω	0.32Ω	0.8Ω	1.6Ω

## 12 Volt Trigger Ins and Outs

There are five ways The Director M6800D may be awakened from standby for operation, and to trigger additional M6800D units or other components. The table below provides details for this flexibility:

Method	How Triggered	LED Indicator	Mini Jacks Powered*
1	Ethernet	Ethernet Triggered	No
2	12 volt mini plug input*	12 v Trigger Active	Yes, unused jack
3	Jumped Phoenix connector	12 v Trigger Active	Yes
4	Contact closure on Phoenix connector	12 v Trigger Active	Yes
5	12 volt input on Phoenix connector	12 v Trigger Active	Yes

\* +12 volts on tip, mono jack

The following details apply if the Ethernet Web Interface will not be used to turn on The Director M6800D.

### 3-pin Connector

To remotely turn on the unit, use either a contact closure between the Trigger Input and the +12V output, or an external +12V trigger between the Trigger In and GND terminals. DO NOT attempt to use this +12V output to power on additional equipment as it is not designed to do so.

#### Pinout:

GND Ground  
+12V Output  
+12V Trigger Input

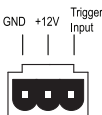

### 1/8" TS mono jacks

These are wired in parallel to each other, and work in conjunction with the 3-pin connector. Both jacks may function as inputs or outputs. Either jack can receive a +12V trigger as an input, which will turn on the unit. The second jack is then available and functions as a +12V output that may be used to turn-on a second unit. If the 3-pin connector is used to trigger the unit, then both of the 1/8" jacks may be used as output triggers for other units.

#### Pinout:

Tip = +12V Trigger Input  
Sleeve = Ground

**THE DIRECTOR™**

Model M6800D

Installation Manual

## Power Up Process

When +3 to +12V is sensed by either of the 1/8" TS mono connectors, or at the 3-pin connector, as an input trigger signal, the rear panel master trigger indicator LED changes from off to illuminate blue. All zones remain in standby for approximately 2 seconds until the power supplies have fully charged and completed self-diagnostic testing. During this short interval, the front panel Power and Protection LEDs remain red. Once this process has been completed, the Power LED will illuminate blue and the Protection LED will turn off.

## Power Down Process

When 0Volts is sensed at the master trigger inputs, all zones are muted and placed into standby, and the rear panel master trigger LED will change from blue to off. The front panel Power LED will remain on, as the main power supplies remain energized. When the master trigger Inputs have sensed 0Volts for at least 2 seconds, the main power supplies will shut off and the front panel Power LED will change its status from blue to red. The Protection LED will flash red once during the power-down process. The trigger input is biased toward ground. This keeps the unit in standby when nothing is connected. If triggering is not performed using the master trigger of the Ethernet connection, a short wire linking the +12V output to the trigger input must be installed. To return the unit to standby, simply remove the link.

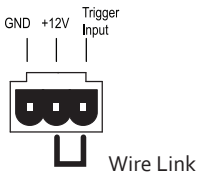

### To trigger ON with a contact closure

Connect the contact closure between +12V and the Trigger Input

### To trigger OFF with a contact closure

Connect a 1 kΩ resistor between +12V and Trigger Input

Connect the contact closure between the Trigger Input and GND

### To use an external 12V trigger

Connect the external ground to the Director M6800D GND

Connect the external +12V output volt-age to the Director M6800D Trigger Input

# Ventilation

The Director M6800D features cool-running, efficient switch mode power supplies and Class D amplifiers, equipped with thermally controlled fans. As high-powered 16-channel amplifiers, proper ventilation is required to maintain sufficiently cool operational status.



Please be advised that no more than 4 Director models may be stacked together. Any more than that, then a rack space above and below is required for adequate ventilation.



Review the heat load specifications and ensure that your rack room meets these requirements.

Ideal Spacing 1U rack space or more above and below each pair

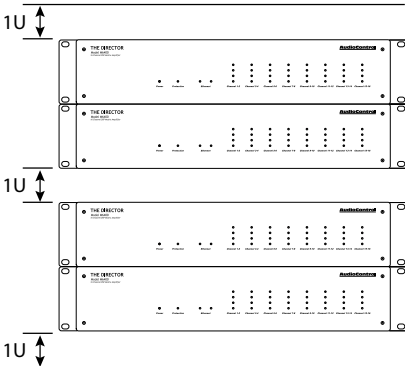

If the amplifier should happen to overheat, a thermal sensor places it into standby mode, enabling the heatsink to cool down. Once the amplifier has attained a safe operating temperature, it will reactivate. If this occurs often, the cause must be identified and corrective action taken.

This may include:

- Additional ventilation
- Ensure the installation location does not have limited or no airflow
- Install heat extraction fans in the rack, or the installation location
- Determine if the amplifiers are overloaded by speaker impedances below the recommended minimum
- Inspect speaker cables and speakers for signs of short-circuiting.

Note: Zones shut off independently when a fault such as a short circuit is detected.



No more than four units can be stacked without a rack space between them. Allow 1U rack space or more above and below each stack of four.

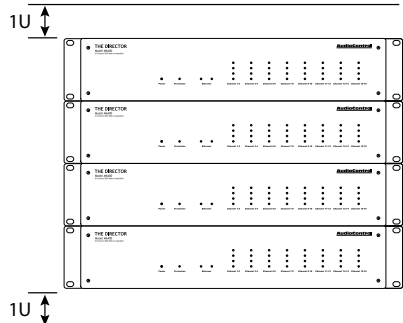

**THE DIRECTOR™**

Model M6800D

Installation Manual

## Internet Connectivity and Control

Setting up The Director M6800D for Ethernet control is effortless. Simply connect it to the network it will reside on and allow the DHCP server to assign the M6800D an IP address. Take note of the unit's MAC address on the chassis rear adjacent to the model name and serial number. Write down or use a phone camera to capture it for reference. After the M6800D has acquired an IP address from the DHCP server (this may take a few seconds), scan for this address on the network. Enter the address into a browser and the M6800D Operations page will open up.

Other than connecting to the browser for initial setup, configuration, and EQ settings, the M6800D may be controlled via Telnet, through Telnet port.



---

# Control Using a Browser

## Microsoft operating systems

Connection to the M6800D for setup or control can be made over a network or directly. One way is to simply connect over a network with a DHCP server via the Ethernet port on the M6800D and allow the unit to obtain a local address. Zip code is not needed. If a direct connection to the M6800D is preferred, make a connection between the two devices with an Ethernet cable. The connected computer will require a static IP address, with 192.168.0.249 the default address of the M6800D.

With a Windows-based computer, change the computer IP address to a static address of 192.168.0.x – where x is a value between 1 through 254, but do not use 249. Verify the static address selected is not in use by another device on the network, unless you want to start the *War of the Worlds*.

## Important Note

The Director M6800D initially defaults to DHCP. If a DHCP server is not found, the M6800D will subsequently default to an IP address of 192.168.0.249. If DHCP will not be used and a static IP address will be assigned, provide the M6800D an IP address first via direct connection with the computer. Never allow two devices to share an IP address on the same network.

## Apple/Mac Desktops and Laptops

Direct connection is the easiest method for connecting the M6800D with Apple computers. The default IP address of the M6800D is 192.168.0.249 which will require the Apple computer to have a static IP address.

Provide the Apple computer with a static IP address of 192.168.0.x – where x is a value between 1 through 254, but do not use 249. Verify the static address selected is not in use by another device on the network.

## Communications Options

The M6800D's web server "Device Configuration" page contains many communication options.

## Here are a few notes

Server Gateway must be specified in order to access the SNTP time server. DNS must be specified as well for the SNTP and SMTP functions to work – 8.8.8.8 (Default) or 8.8.4.4 are public DNS servers Google has enabled for use.

## Control via Telnet Commands

Controlling the M6800D in an automation network requires system management that can send and receive telnet commands and responses.

The command and response structures of the controls provided via telnet are in simple human language. Power On is simply "power1" followed by a carriage return to end the command. Command feedback is confirmed by an echo of the command, followed by a carriage return, then another statement of "01" followed by the command string, then a carriage return and a line feed to end the response string. If there is a value-change like volume up, then the confirmation response will include the new value at the end of the string.

## Telnet Session Length

Sending the M6800D a command opens a telnet session – simply send a command and a response follows. A session will remain open for 4 hours, and then close (enough time to finish *Gone With the Wind*). If another command is received within that 4 hours, the session clock restarts. The session will close 4 hours from the time of the last command received (about the same length as your co-workers stories). If the automation system being used considers this type of activity as the M6800D dropping off the network, a good practice may be to set up a periodic ping query.

## Control Command Examples

**Increment volume by 1, in Zone 3, where volume before the command is 51:**

Command: Z3vol+<CR>

Response: Z3vol+<CR>

01Z3vol52<CR><LF>

**To turn on main power:**

Command: power1<CR>

Response: power1<CR>

01power1<CR><LF>

**To mute or turn Zone 5 off:**

Command: Z5off<CR>

Response: Z5off<CR>

01Z5off<CR><LF>

## Note:

The query ZONEON? returns a description of the on state of all the zones, where each zone is separated by a space.

1 equals on, and 0 equals off. So if zones 6 and 7 are on and all the other zones are off the information will be displayed like: 0 0 0 0 0 1 1 0 0 0. Also note that the last two values in position 9 and 10 are reflecting the state of the digital outputs.

The response to the query ZONEOFF? will return the opposite values if zones 6 and 7 are off as it is confirming that the zones are off so that value is positive:

1 1 1 1 1 0 0 1 1 1.

Please visit our website for additional information and a table of control commands:

[www.audiocontrolpro.com/director-model-m6800d.html](http://www.audiocontrolpro.com/director-model-m6800d.html)

*\*As things in the fast-paced world of technical documentation are constantly changing, visiting our website is one way to make sure you have the latest information.*

## Set up via the Web Page

Enter the IP address of the unit on any device that supports browser use. The web page is responsive - meaning that it will auto-size to fit the device screen size. When using a small phone, the layout adjusts to that size and will also be touch-sensitive. On a computer, the web page will adapt to the browser size. Configuration for all the parameters of The Director is made through this interface. The initial view of the web page shown below illustrates the current state of the unit.

To access global settings, click on the “gear” icon at the top right of the page. To change zone settings, click on the caret (the “v” icon) to expand the selections. Simply clicking on an option will expand the adjustable parameters. These configuration options allow customization to The Director’s performance to match any system design.

*Clicking the caret expands the menu options for each Zone or Digital Input*

*The gear icon opens and closes the global settings menu*

The screenshot displays the web interface for the Director Matrix 6800D. At the top, there is a header bar with a power icon, an ID button, the text "DIRECTOR MATRIX 6800D Director Matrix 6800D", and a gear icon for global settings. Below the header is a "ZONES" section. The interface is divided into four zones, each with a power button, a volume icon, and a dropdown menu. Zone 1 is expanded, showing "ZONE 1" and "INPUT 1-2" options. Each zone has a "GRP" dropdown, "ON VOL (%)", "MAX VOL (%)", and "TRIM (dB)" sliders. The "ON VOL" and "MAX VOL" sliders are set to "Bypass" and "100" respectively. The "TRIM" slider is set to "0". Below the zones, there are buttons for "SPEAKERS", "X-OVER", "EQ", and "STEREO". At the bottom, there are "BYPASS" and "NO FILE LOADED" buttons.

**THE DIRECTOR™**  
Model M6800D

Installation Manual

Global Standby

ID (Identify)

Global Settings

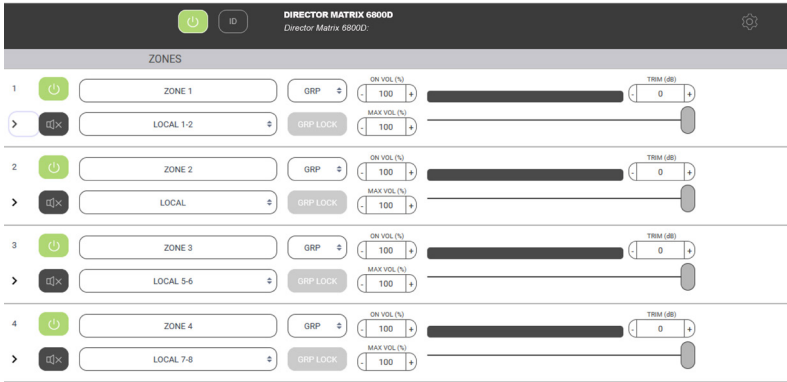

### Global Standby

This is basically a main power-off where the amp, power supply and DSP are shut down. Power up from this state is about 10 seconds.

### Global Settings

Expand this panel for additional controls. See page 32 for more details.

### ID

Pressing this button will cause the two ethernet lights to flash in tandem on the front of the unit. This is useful if there are multiple units in operation, and you want to make sure you are adjusting the right one.

### Zones 1-8

The settings in each section defines the rear panel speaker-level output to each of these 8 zones.

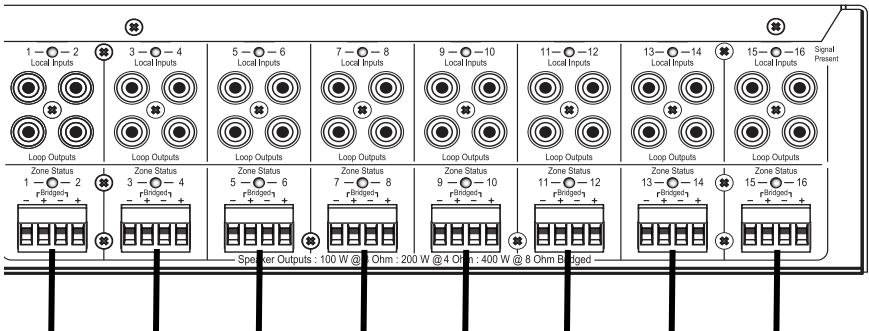

Zone 1 Zone 2 Zone 3 Zone 4 Zone 5 Zone 6 Zone 7 Zone 8

## Zone Settings

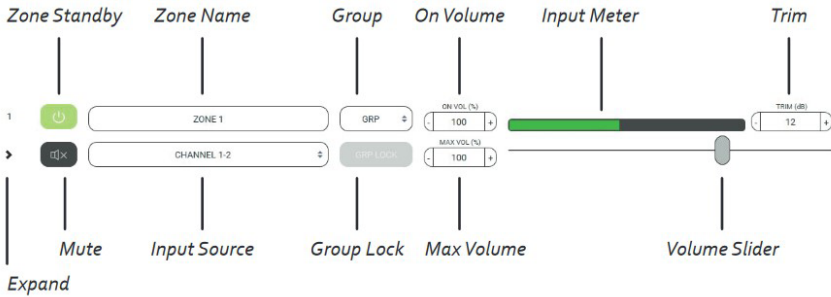

### Zone Standby

Turns only the associated zone amplifier on or off to enable virtually instantaneous output when the zone is activated. In less than 500ms, the zone swings from standby to on. Boot-up time is eliminated.

NOTE: When set for Signal Sense, both Global On and Zone On should be set to respond to signal input.

### Zone Name

Zone names can be changed by typing in this box. When a new name is entered, select the check box to the right to save all changes. Up to 30 character spaces are available for custom naming.



### Expand

Select for more options in this zone.

### Mute

Select to quickly mute or unmute the output from this zone.

\*mute\* "Maaaa, Meatloaf" \*unmute\*

### Input Source

Select the input source that will play in the zone. Pink Noise is available to assist with volume settings and acoustic calibration in each zone.

The name of each input source can be changed using the Global Settings/ Input Sources menu and the changes (when saved) will appear here.

Zones that are assigned to the same group may share any input, including Dante sources.



THE DIRECTOR™

Model M6800D

Installation Manual

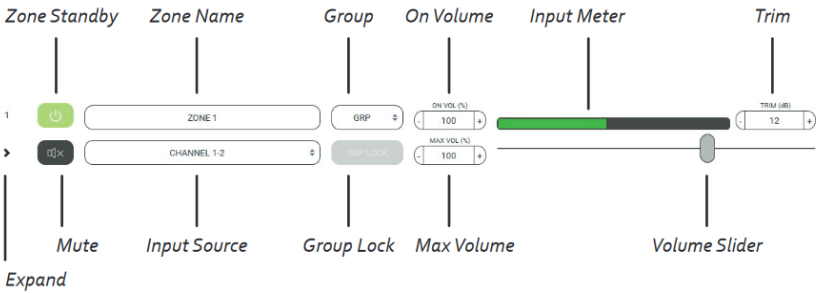

## Group

Each zone may be assigned to a group in the drop-down menu. Select a group for a particular zone to belong in, from 1 to 8, or allow it to remain on GRP if this feature is not being used.

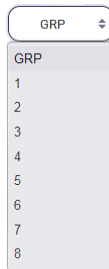

## Group Lock

If the zone is assigned to a group, select to activate this function.

When Group Lock is selected, the following message appears:

**“Proceeding will set the volume of all the zones in the group (that also have group lock engaged) to the minimum of them.”**

The feature works as follows: If Zones 1, 2 and 3 are to be assigned as Group 1, select Group Lock for each one of these zones. Each Group Lock button will turn to orange when selected. When this sequence has been completed, the volume level for all zones in the group will adjust to match the zone with the lowest level when the group was assembled. A change in volume to any zone in the group collectively changes the group volume. If the input source is changed to a Bus input, all zones in the group will follow.

## On Volume

Sets the zone volume to a specified startup value. If the volume in the zone was higher prior to the new value change, the new selection becomes the default.

## Max Volume

Sets the maximum volume level of the zone.

## Input Meter

Provides a graphic depiction of the incoming signal level.

## Volume Slider

Primary volume adjustment in a zone.

## Trim

Enables fine-tuning for zone volume. This is particularly useful when multiple zones are grouped into a single listening area. An example might be 3 speaker pairs, individually zoned, that provide audio for a large Living Room. Equalization may inadvertently accentuate one pair creating the impression they are louder. Trim can assist with acoustic balancing in the area. Trim interacts with the Volume Slider to establish an overall peak threshold in zones where end-user control may inadvertently chance speaker damage. Input levels may be set using the Global Settings/ Input Sources menu.

# Zone Options

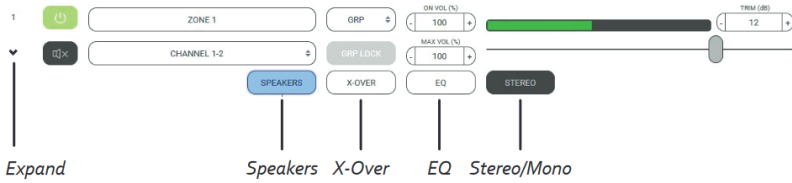

## Speakers

This is where speaker profiles are accessed. Speaker profiles contain optimized settings that select speaker manufacturers have compiled to maximize the performance of their models when powered by the M6800D.

## X-OVER

This enables access to the Low Pass, Band Pass, and High Pass crossover filters to control the frequency ranges the M6800D sends to speakers.

## EQ

Enables access to the graphic and parametric EQ filters to precisely match speakers to the acoustic environment they operate in.

## STEREO/MONO

Output may be set for mono playback or stereo.

## Speakers

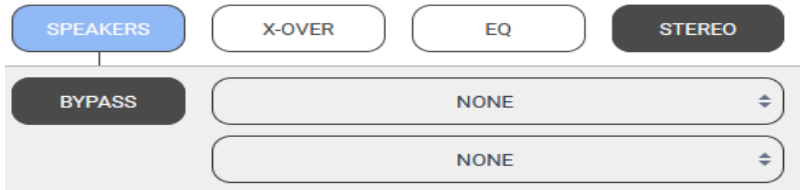

### Speaker Calibration Profile

Speaker Profiles contain equalization and crossover settings that have been carefully selected by certain speaker manufacturers to be the ideal performance metrics for their particular speaker model. The profile, when selected, is applied in the background and not illustrated by the M6800D GUI. With speaker profiles applied, graphic EQ adjustments may still be made to fine-tune the speaker's response in the room, and/or to accommodate client preferences. Each zone may be assigned a different profile, to accommodate different speaker models.

**NOTE:** Speaker profiles are not pre-loaded as standard presets on the M6800D. They are available for download from the AudioControl website.

Available speaker profiles are updated regularly. Please check our website for the latest additions.



## X-Over

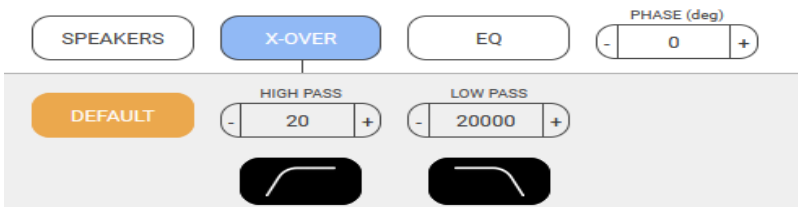

Here you can adjust the range of frequencies that play through the selected output. Each box allows you to type in the desired frequencies or you can adjust with the +/- buttons for a Kubrikian level of detail. The high pass filter can be set between 20-15000Hz, and the low pass between 30-20000Hz. Pressing the Default button returns the crossover to its default full range setting, and the non interactive icons below help illustrate how the highpass and lowpass features work.

To prevent stressing woofers from frequencies lower than they are designed to safely handle physically, use the subsonic filter. For inwall speakers in relatively compact footprints (not exotic floor to ceiling inwall line arrays) we recommend a setting near 40 Hz or higher. Contrary

to popular thinking, a higher setting contributes to making this low frequency filter sound better. Similarly, for delicate tweeters, conservative settings with the high-frequency filter that protects tweeters could prevent service calls. The M6800D is capable of easily delivering vast amounts of power to any type of speaker (do not be fooled by the M6800D's lighter weight, Class D amplifiers are deceiving). A 2-way crossover can be set up with a subwoofer dedicated to the low end, and a pair of speakers playing mids and highs. Enable the Low Pass Mode filter, and bridge two zone channels into a single, high-powered mono subwoofer channel. These combined channels will receive only the low frequencies (monaurally). Use two channels from another zone to power a stereo pair of high-range speakers with the High Pass mode (like from Cheech to Chong) selected for that zone.

**THE DIRECTOR™**

Model M6800D

Installation Manual

## EQ Ramblin's

A change to equalization settings within a zone will affect both channels. A later section of this manual addresses the methods and benefits equalization offers acoustic spaces. Equalization is a powerful tool, however, it requires effort for accurate results. Easily overdone, like lens flares in an Abrams film, misadjustment may deliver a more poor-sounding response curve than no adjustment whatsoever. Available audio analysis instrumentation will take the guesswork out of successfully setting the EQ for each zone.

### Graphic EQ

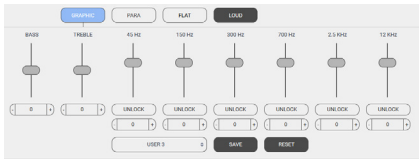

Use the graphic EQ to make relatively broadband adjustments to speaker interaction within a selected zone. As both channels are adjusted simultaneously, selecting "UNLOCK" enables independent channel adjustment. Changes are made by selecting a parameter and dragging the slider from its default to the desired new position. Below UNLOCK, there is another tab with a value reading in the center and flanked on the sides with +/- adjustment tabs. These are stepped versions of the sliders. Note that the sliders or the steps offer the ability to back a particular frequency adjustment down from its default position. A hardsurfaced, reflective room may benefit more from reducing acoustic

energy in a particular frequency band than adding it to another.

A large tab at the bottom of this menu accesses preset equalization settings, including custom curves created and saved. Select the adjacent SAVE tab to store an EQ curve, or on the far right, select RESET to restore defaults and begin again.

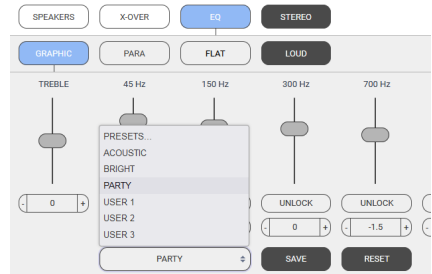

Settings with various EQ curves may be saved to the memories from which end-users may select their preferences.

## BASS and TREBLE

The two sliders at the extreme left of the graph are conventionally labeled BASS and TREBLE. When adjusted their effect is more global than other tabs that are isolated to a regional frequency range. BASS and TREBLE may be referred to as Shelving EQ adjustments, which boost or cut a wide band of frequencies with equal energy in the high-frequency range of the spectrum or in the low-frequency range, above or below a certain frequency. Start with the graphic EQ at "flat" and slowly apply a bit of shelving bass or treble EQ and determine if that evens out speaker response for the zone.

## Parametric EQ

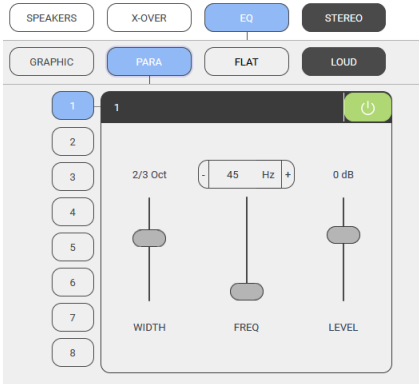

In addition to Graphic equalization, there are 8 separate Parametric equalizers per zone, for the ultimate in room-acoustics problem-solving (or perhaps, problem-creating). Each parametric EQ has adjustments for the octave width, frequency, and level boost or cut. An example of use would be detecting a room resonance where a certain frequency induces an audible vibration or to something located in the space. A narrow-width filter can be crafted to reduce the energy level in the signal at the precise frequency point where the resonance occurred. Once parametric EQ settings are finalized, return to the Graphic EQ menu and select SAVE.

## Stereo/Mono

Select this tab to combine both channels in a zone into mono. This is useful when the channels are bridged for a single speaker, such as a subwoofer. It is also beneficial in large or outdoor zones where stereo imaging is impractical or impossible. One or two pairs of speakers connected as normal (pay heed to impedance) will play content so all details are audible from any listening position.

## Loud

Select this tab to apply an equal loudness curve to music. At lower volume levels, the human ear is less sensitive to the low and high frequency extremes of the audible spectrum compared to mid-range frequencies, where hearing is more acutely sensitive. At higher volume levels, the response is perceived as more “flat”. To simulate this flat frequency balance for low listening levels, the loudness circuit boosts low frequencies and high frequencies, leaving the middle range untouched.

## Global Settings

Selecting the Gear Icon accesses Global configuration options.

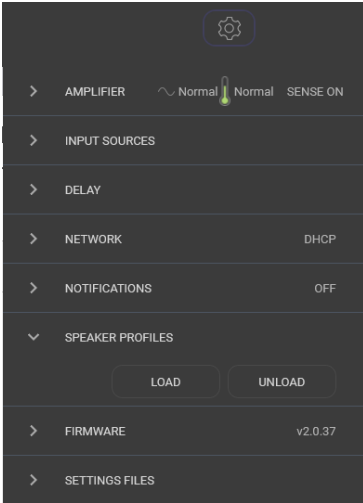

### Amplifier:

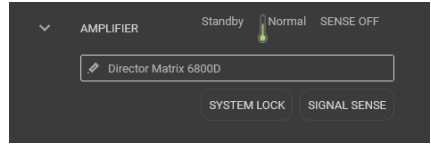

If desired, the unit may be renamed by typing inside the box and then selecting the check mark. AC mains and thermal status may be monitored. SIGNAL SENSE may be adjusted to on or off by toggling the tab, with the status displayed in the top right. SYSTEM LOCK is also a toggle, but to proceed requires that a system password be entered. NOTE: Once the system has been locked, control over parameters is only possible by entering the password. Retain the password with all other critical project data.

## Input Sources:

ID	SENSITIVITY	NAME	Save Changes
1-2	1 Vrms	Input 1-2	<input checked="" type="checkbox"/>
3-4	1 Vrms	Input 3-4	<input type="checkbox"/>
5-6	1 Vrms	Input 5-6	<input type="checkbox"/>
7-8	1 Vrms	Input 7-8	<input type="checkbox"/>
9-10	1 Vrms	Input 9-10	<input type="checkbox"/>
11-12	1 Vrms	Input 11-12	<input type="checkbox"/>
13-14	1 Vrms	Input 13-14	<input type="checkbox"/>
15-16	1 Vrms	Input 15-16	<input type="checkbox"/>
Digital In A	1 Vrms	Digital In A	<input type="checkbox"/>
Digital In B	1 Vrms	Digital In B	<input type="checkbox"/>

Sources may be custom-named. Type inside the box, and when complete, select the check mark at the right in each box to save changes. NOTE: Save after each change and before proceeding to rename the next input or changes will not be saved). New names will appear in each Zone list.

INPUT 1-2

- > INPUT SOURCES
- > DANTE INPUTS
- > CMSeries-FFFE3F-CM2-750
- > CMSeries-FFFE18-CM2-750

There is an option to change input voltage sensitivity. Common audio source outputs range from 1V to 2V. 1.5rms may prove to be the best setting.

## Delay:

Zone	Delay (ms)
Zone 5	0
Zone 6	0
Zone 7	0
Zone 8	0

Delays between zones may be set in 5-millisecond increments to balance audio across large areas.

## Network:

Field	Value
IP ADDRESS	192.168.0.249
SUBNET MASK	255.255.255.0
GATEWAY	192.168.0.1
DNS	8.8.8.8
AUTOMATION PORT	23

SAVE CHANGES

Configure all network settings in this menu when the M6800D is set up manually. When set up is automatic, ensure the DHCP button is selected. The default IP address of the unit is 192.168.0.249. Manually connect peer to peer for troubleshooting.

THE DIRECTOR™

Model M6800D

Installation Manual

## SDS – Signal Detecting Switching

A highly desirable integration feature called Signal Detecting Switching, or SDS is incorporated into the Director Matrix series. SDS enables third-party automation systems to route door station audio, or any voice-activated device, into the M6800D for distribution through residential or commercial audio systems. Any input channel (or stereo pair) may be configured as the designated SDS input, while any or all zone outputs may be selected as announcement or paging zones. When an incoming audio signal is detected at the SDS input, audio present in assigned SDS output zones is completely muted until the announcement has been completed, at which time previous signals will resume playing.

Setting up Signal Detecting Switching is accomplished easily and quickly.

- Using a computer connected to the same network as the M6800D, enter the amplifier's IP address into a web browser. If the IP address is unknown, use an IP scanner to search for the amplifier on the network.
- The menu will appear shown here:

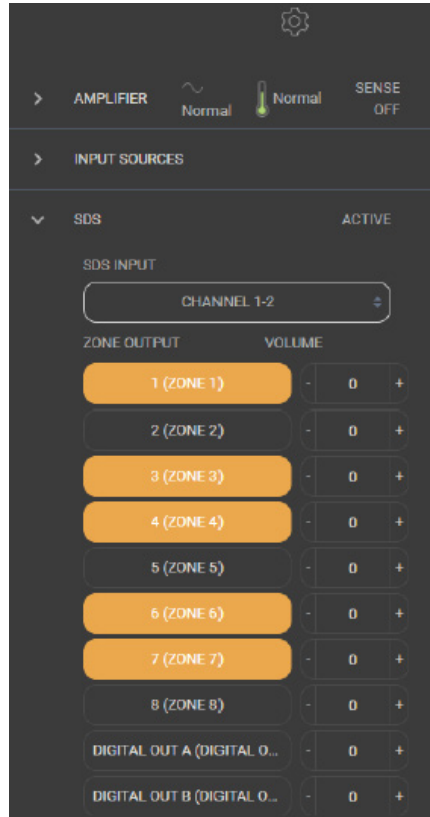

- Once detected, log into the Web Interface, select the gear icon in the upper right corner, and open the settings menu.
- Locate the SDS tab, and in the SDS Input drop-down list, select the input that will be assigned as the SDS input. The input button will change to orange.
- Select the Zone Outputs that will operate for SDS, including the two digital outputs.
- Volume levels for announcements are adjustable in each SDS output zone.

## Speaker Profiles:

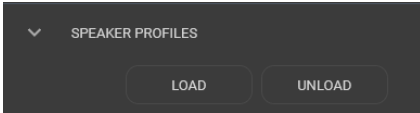

Speaker profiles are not pre-loaded. Profiles for select speaker models by our speaker partners may be downloaded from [www.audiocontrolpro.com](http://www.audiocontrolpro.com) and uploaded to the Director M6800D by using the LOAD option.

## Firmware:



Update firmware using this menu. **NOTE:** Backup current SETTINGS FILES and export before updating firmware. Firmware files can be downloaded from: [audiocontrolpro.com](http://audiocontrolpro.com)

## Settings Files:

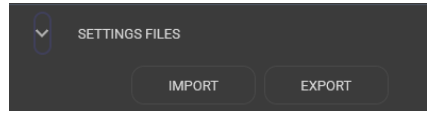

All settings for The Director M6800D may be backed up and exported. Every parameter is stored into a single external file.

**NOTE:** It is important to save each zone's configuration settings into a user memory. Even if there are not multiple recallable EQ memories, it is still necessary that zone configurations be saved in the event of a total loss of power. The SAVE function, in the Graphic EQ section for each zone, saves the EQ for that zone as user presets. The EXPORT button functions as a global save for settings in all zones. It is an overall snapshot of all M6800D settings. All Graphic, Parametric EQ settings, plus any Crossover settings are retained in the exported file. These settings may be used for backup purposes, or as a template for use in future projects.

### Selecting the IMPORT

To load settings, select IMPORT, then select an exported saved file that contains current settings, or search for a file with previously saved settings.

With all these Imports and Exports, it makes me want to rip off my sleeves, crack open a Corona and work on my RX-7 or Skyline. Family.

## Dante Configuration:

In this menu, other AudioControl Dante-enabled products may be scanned for. It is also where the device ID is set, enabling communication and data exchange in an automated environment where other Dante-capable DM68ooD or CM series units are in operation. To begin, open the “Dante Configuration” option in the Global Settings dropdown, and set the ID for this DM68ooD. If on a network with additional Dante devices, select “Look for other devices.” This process will populate the input selection menus of remote AudioControl CM and Director series amplifiers into this local device menu, making those remote inputs available for use by this local amplifier.

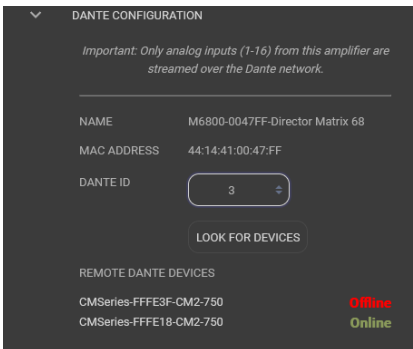

Agnostic, third-party-automated system integration also is done with this menu. Set the DM68ooD as the first AudioControl Dante-enabled unit you are logging as Dante ID 1. The unit will scan for other Dante devices to make sure position #1 has not been taken previously. If an all-clear is given, this device and its MAC address will be known on the system as device #1.

ID all other Dante AudioControl devices on the system so their designations will enable remote control of Dante routing by automation systems like Crestron, Control 4, Elan and others.

Using Dante Controller, physical M68ooD inputs become virtual sources that are available to other Dante devices with input/amplification capabilities. Dante Controller may be used in normal fashion to route Dante sources from any device, making them accessible from the input selection menu and/or the automation system. Inputs may also be renamed and published to the Dante bus which will inform the Dante Controller.



## Acoustics

Media venues that evaluate audio products, including speakers, only do so in what they deem a “reference environment.” Such acoustic settings are incapable of being identically duplicated by consumers of this media, but they impart more impact to the final performance assessment of the product being considered, especially loudspeakers, than any other factor. Acoustics is a complicated subject, like a Nancy Myers film, about which hefty textbooks have been written. We simply want you to be aware of a few basics that have a direct effect on real-time audio analysis. Sound travels in waves. In audio systems, these waves are created by the speakers. Like waves in a pond created by a splash, sound waves emanate from speakers to spread out into the room. If a room were infinitely large, that’s all there would be to it. But just as waves in a pond reach the bank and reflect back, sound waves bounce off walls, ceilings, and floors, reflecting, reinforcing and canceling one another as shown here:

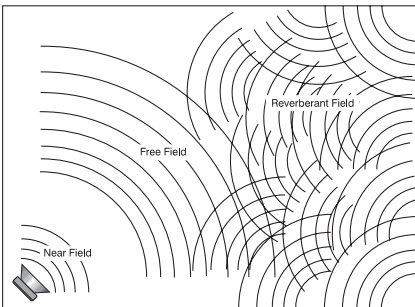

Since sound is energy, the way it reflects depends upon the angle of the surface, the type of surface material and the frequency of the sound wave. A listening position is likely to be nearer the back of the Free Field (waves shown in the diagram) enveloped by part of the reflected Reverberant Field as well.

Added in are the next set of complications: Different frequencies of sound have different wavelengths (a function of frequency and the speed of sound). Each frequency’s wavelength contributes differently to the Free and Reverberant Fields because they are different sizes. For example, a 32 Hz bass note has a wavelength of 35 feet, while a 16,000 Hz note has a wavelength of just under a tenth of an inch. Tiny treble waves can be caught and neutralized by draperies, carpeting, and upholstered furniture while gigantic bass waves simply slosh back and forth within the room.

Another set of variables is the shape and size volume of a listening room. Large rooms require more bass energy to excite waves within them. Small rooms need less energy but reflect it differently. And then there’s the fact that most rooms don’t have four walls anymore, opening into dining rooms, lofts, cathedral ceilings, etc. All of this means that predicting sound interaction patterns is very difficult due to irregularities in room shapes. As you can see, room acoustics is an important but complicated subject. The overall point being emphasized is various rooms in a home function as a gigantic mechanical equalizers, boosting or cutting certain frequencies depending on size, shape, volume, acoustic treatment and the position of the speakers.

**THE DIRECTOR™**

Model M6800D

Installation Manual

## Benefits of Equalization

Rarely is the room and room décor designed to get the best sound from an audio system. Almost always the opposite is the case, where speaker positions and sizes become dictated by factors that are contrary to accurate sound. This real-world situation is where equalization provides tremendous benefits. Speaker positions, furniture, and room layouts may cause peaks in frequency response. Fortunately, these peaks can be tamed by careful equalization. Clients may have specific preferences, and sound may be tailored to accommodate these preferences. Remember, there are memories in The Director M6800D, and different settings via these memories may be used for different sources.

The laws of physics are difficult to violate, although we do try our best. Equalization cannot make terrible acoustics sound terrific, only better. For example, if a room has a tile floor and glass walls, the best result will still be bad by any barometer. While equalization can do wonders to aid a less than perfect speaker, it will never make a mediocre speaker sound fabulous. For the best results, start with well-designed, accurate speakers and reasonable room acoustics whenever possible.

## Equalizing the System

Before proceeding with equalizing the system, it is a good idea to make sure everything is connected and working properly.

These are reminders specific to The Director M6800D, as well as the steps for equalization.

1. Turn on the system. The Power light on the left front panel should be blue.
2. Connect to this specific Director unit over the network by entering its unique IP address into a browser (Firefox, Safari, and Chrome are preferred).
3. Make sure the unit is turned on. Turn off signal sense in the Web Interface on the browser. On the front panel, all zone status lights should start red and then turn to blue.
4. If any zone status lights are not blue, check the Web Interface to see if any zones need to be unmuted.
5. Play (Barbie) pink noise through the system into the zones to be adjusted. The signal is playing through the M6800D when the LED level meter on the front panel responds to the volume.
6. Assuming you have wireless network access and an RTA meter for sound analyzation, go into the zone you wish to adjust.
7. Place the microphone in the middle of the listening area at the height of a typical listener's head.
8. Use the equalizer controls to lower peaks in the frequency response first. Peaks obscure the surrounding sounds. Lowering peaks will unleash overshadowed sounds. You can save different settings to different memories and see which one the clients like. Their taste may be different than yours.

# Parametric and Graphic Equalization

The graphic equalization controls in the M6800D are selected to correspond with the characteristics of in-wall and in-ceiling speakers, and as such are very effective. Graphic EQ controls are the easiest to tune, and provide a “graphic” representation of what the adjustments are. Parametric equalization requires selecting the frequency, the bandwidth of the control, as well as the level of adjustment, not an easy task to get correct. In general, parametric equalization is valuable for very large areas of change or very narrow areas.

Parametric equalization in the M6800D is best used for taming very narrow peaks. Do not use it for very narrow dips, as these dips are likely caused by cancellations and will not respond to boosts in equalization.

Here is an introduction to each of the graphic control frequencies and their effect on music.

## 45 Hz — Low bass

- This is about the lowest frequency that in-wall and small bookshelf speakers can achieve. Boosting it too far might cause problems, even though the subsonic filter in the M6800D cuts frequencies below this adjustment point. But, if your speakers can take it, a mild boost will enhance bass instruments such as bass guitar, kick drum, floor toms, timpani and double bass violas.

## 150 Hz — High bass

- There is a lot of bass information at this frequency. In fact, most modern music is mixed to enhance this area of the frequency spectrum. 150Hz also determines the depth of male vocals and contains reverberant information which contributes to the spaciousness of sound. Boosting 150Hz can add slam and impact to bass or it can make the sound hollow and boomy. This is a critical adjustment with small or in-wall speakers. Experiment with this range.

## 300 Hz and 700 Hz

- High and low midrange. These controls directly affect the sound of instruments and vocals. These bands also determine the speaker’s presence (whether the music sounds far away or close in). Small speakers often produce too much midrange, so these controls can be turned down slightly during your initial experimentation. Consider reducing 700Hz when architectural speakers are only used for low-level background music.

## 2500 Hz — Treble

- Female vocals and the transients of instruments such as guitars, snare drums, saxes, violins, etc. are found in this range. If accentuated too much (by boosting this control) sound in the 2500Hz range can seem harsh and fatiguing to the ear due to excessive output by the speaker or because of live, reflective room acoustics.

## 12 kHz — High treble

- The fine detail, texture and shimmer of music are found here, such as the breathiness of vocals, the “sheen” of cymbals, and the high overtones of piano and strings. Actually, there’s audible music information up to 20,000Hz on some CDs and hi-resolution streaming services, with many adult’s hearing very well at 15,000Hz. 12,000Hz was chosen because it provides more useful control to compensate for room acoustics and common small-speaker deficiencies.

## Subsonic and Tweeter Protection Filters

The Subsonic (aka High Pass) filter and Tweeter Protection (aka Low Pass) filter are adjusted on the M6800D signal processing web page, along with equalization. Their function is simply to make speakers sound better, play louder, and last longer.

All speakers have frequency response limitations. For their best performance, speakers should operate in their linear zone. This is the range where sound reproduction is not compromised by mechanical limitations.

If speakers operate near or at their mechanical limitations, the sound they reproduce is compromised and elements of the speakers are stressed and, in some cases, will heat up shortening their longevity. The tweeter protection and subsonic filters are very important tools. Experiment with higher subsonic filters, and lower tweeter protection settings than are suggested from published specifications for the speaker. Experiments with higher/ lower settings, will very likely, sound much better than pushing frequency limits. Speakers will be less stressed and last longer.

## Presets

There are six memory presets on the The Director M6800D for a variety of different setting configurations. These memories are saved on the Signal Processing tab. When saving a memory, all signal processing page settings (equalization and filters) are saved.

## Advanced Discussions

### In Wall Volume Controls

While in-wall volume controls are used less now, replaced by automation systems with wireless control for volume performed by system controllers, they may exist in some installations.

The M6800D is capable of producing more power through a volume control's circuitry than it can safely handle. Only use a volume control that is rated for the power of the M6800D into a 4 Ohm load, which is 200 Watts per channel, and with a margin of safety headroom. In all likelihood, such a control does not exist, as this is an extreme amount of power.

### Installation of multiple units

**How many The Director M6400, M6800, and M6800D units may be stacked without ventilation space between units?**

- A maximum of 4 units may be stacked, one atop another, provided one unit-free rack space is above and below the stack. Consider how the units will be configured and the impedance loads they may be operating under. In an installation where high to maximum output power may be the norm and not the exception, increased ventilation and alternative cooling methods are recommended.
- Ideally, 2 units stacked with unit-free space above and below will improve air flow to the units.

**May you daisy chain or Y-cord audio and power trigger connections?**

- Y-cords are not necessary nor recommended, as the Loop-output jacks are designed to pass signal to the next amplifier. Use high-quality cables for signal extension.
- For power control, it is easiest to have an Ethernet connection to each unit. The 12 volt mini jacks are powered to turn on another unit when the main unit is on (not standby). If you need more than 15 milliamps current on the 12 volt output, use a relay to prevent over loading The Director. (The Director itself only takes 1 milliamp to turn on.)

**What are the power requirements and BTU outputs of The Director?**

- More detailed information is shown in the specifications section. In general, we feel conservative, real-life design criteria is 1/8th power. This will be a quite loud listening level for most rooms and assumes all zones are driven at the same time. You will be amazed at how cool the M6800D is at this level. One rule does not fit all situations, so knowledge of the particular circumstances involved needs to be applied. Also, see the section below on unique rooms and SPL.

**How many units may be put on one 15-amp breaker?**

- It depends. Since most codes limit each device to 1500 watts, there should be a separate 15-amp circuit for each unit.

**THE DIRECTOR™**

Model M6800D

Installation Manual

- The circumstances where the M6800D draws maximum power are very rare outside of an engineering lab. Maximum power is using a sine wave input which has at least a third higher energy density than music. This would mean all channels are operating at maximum, which is an unlikely situation, even if you are trying to resurrect Frankenstein, and even more unlikely is all channels on multiple units operating at full output.
- If the only use is background music, then the one-eighth power in the specifications is a reasonable (actually conservative) power draw. A margin of safety for unusual circumstances should be included. Always follow all National and local electrical codes.
- Commercial noise masking systems rely on “white noise”, which sounds remarkably like a bathroom exhaust fan plus the sound of water in a shower, both of which are louder than the background noise level in other parts of a house. Today’s bathrooms typically demand multiple pairs of speakers for these reasons.

#### **What about large rooms as well as rooms where the listener is far from the speakers?**

- Typical in-wall speakers are designed to be near the listener. In common rooms with eight foot ceilings and other usual dimensions, in-wall speakers typically are not much more than eight feet from the listener. In large mansions, the game changes. Twenty-foot ceilings are normal and typical speakers are too far away to provide the client much SPL (sound pressure level). There are in-wall speakers designed for these longer “throw” distances. In general, larger rooms with more height require more speakers and speakers with tighter “directivity” to get party-level SPL. In this case, size matters, and larger speakers will perform better.

#### **What should I use the “Trim” controls in the browser for?**

The Trim controls are an easy-to-access level setting control which you can use while in the zone. The Trim controls allow minor, not major adjustments.

#### **Unique Rooms and SPL in Large Areas: Are there any special considerations for bathrooms?**

- Bathrooms are irregular rooms with high ambient background noise. This noise is often a noisemasking type of ambient sound, in a highly reflective acoustic space, and sometimes fairly large. Modern bathrooms are often some of the most challenging audio environments.

#### **What about haunted locations and rooms?**

- Who you gonna call?
  - » Ghostbusters.

# Troubleshooting

Many problems can be eliminated by re-checking the wiring and settings of the unit. If a problem cannot be solved using the guide below, please call the AudioControl team for further assistance, or e-mail us at [techsupport@audiocontrolpro.com](mailto:techsupport@audiocontrolpro.com)

## 1. No Sound

- a. Verify the Power LED is Blue.
- b. Verify Protection LED is Off.
- c. Verify Zone Status LED is Blue.
- d. Verify that the correct input has been selected in the Web Interface menus
- e. Verify the source unit is operating.
- f. Check the speaker connector plugs on the rear panel are secure.
- g. Unplug the power cord and check the AC Power Fuse on the rear panel.

## 2. Protection LED is off, but none of the Zone Status LEDs are on:

- a. Defeat the signal-sense circuits using the signal sense switch on the Web Interface Web Interface. All of the zone status LEDs should turn on. If they do not, call AudioControl's customer service.
- b. Verify the source unit is operating.
- c. Increase the preamp volume if signal sense is engaged, or just going steady.

## 3. Channel Status LED is Red:

- a. Check speaker leads for a short. Swap speaker connectors on rear to see if the problem moves with the wires.
- b. If the unit is excessively hot, turn down the volume and allow it to cool off. The protection LED should turn off after a short while. Verify that any ventilation holes have not become blocked.
- c. The speaker impedance may be too low. Use an ohmmeter to measure the impedance on the speaker wires.

## 4. Speaker channels are cutting in and out:

- a. If using external volume controls, check that they can handle the power output.
- b. Make sure the speaker impedance is not less than 4 Ohms, or 8 Ohms when used in bridged mono.
- c. There may be a short in the wires. Suspect a short if the problem happens only at the highest volumes.

## 5. Protection LED is Red:

- a. Disconnect power from the unit for 3 to 4 minutes and reconnect to power.
- b. Disconnect all speaker wires. If it still turns red, and the unit has cooled, something rather serious has happened inside the unit. Call AudioControl's lonely folks in customer service.
- c. We are going to need a bigger boat.

**THE DIRECTOR™**

Model M6800D

Installation Manual

6. **Speaker Buzzing or Crackling at high volume:**
  - a. Reduce any preamplifier/equalizer low-frequency boost.
  - b. Ripley: "there's an alien on this ship, get out of here"
7. **There is no audio input signal, but the Zone Status LEDs are still blue:**
  - a. Check the signal-sense switches in the unit's Web Interface tabs. If they are not engaged, the zone status LEDs will stay on as long as the master trigger is enabled.
  - b. The zone status LEDs stays on for 2 minutes (depending on music volume) after the audio signal has stopped. This delay helps prevent prematurely muting during quiet passages or song changes.
8. **The unit is on but you cannot trigger it off**
  - a. The unit will stay on if either the 12v master trigger is on, or jumpered on.
  - b. If the unit has come unplugged and is still powered on after 4 hours, please consult your physician.
9. **Is an in-wall volume control rated at 80 Watts (continuous) adequate?**
  - a. Just barely is the simple answer. Go for one with a higher rating if you want a reliable long-lasting system. Though the Director M6800D is rated at 100 Watts, it is a conservative number, and it can put out more power if only a few channels are driven. In contrast to the conservative rating of the Director M6800D, the wall volume control may be rated using favorable assumptions. Also make sure the volume control power rating is continuous not peak. The continuous rating is about one-third of peak.
10. **The Director M6800D looks like this:**
  - a. It has been installed upside down.
  - b. You are trying a new Yoga position.





# Block Diagram

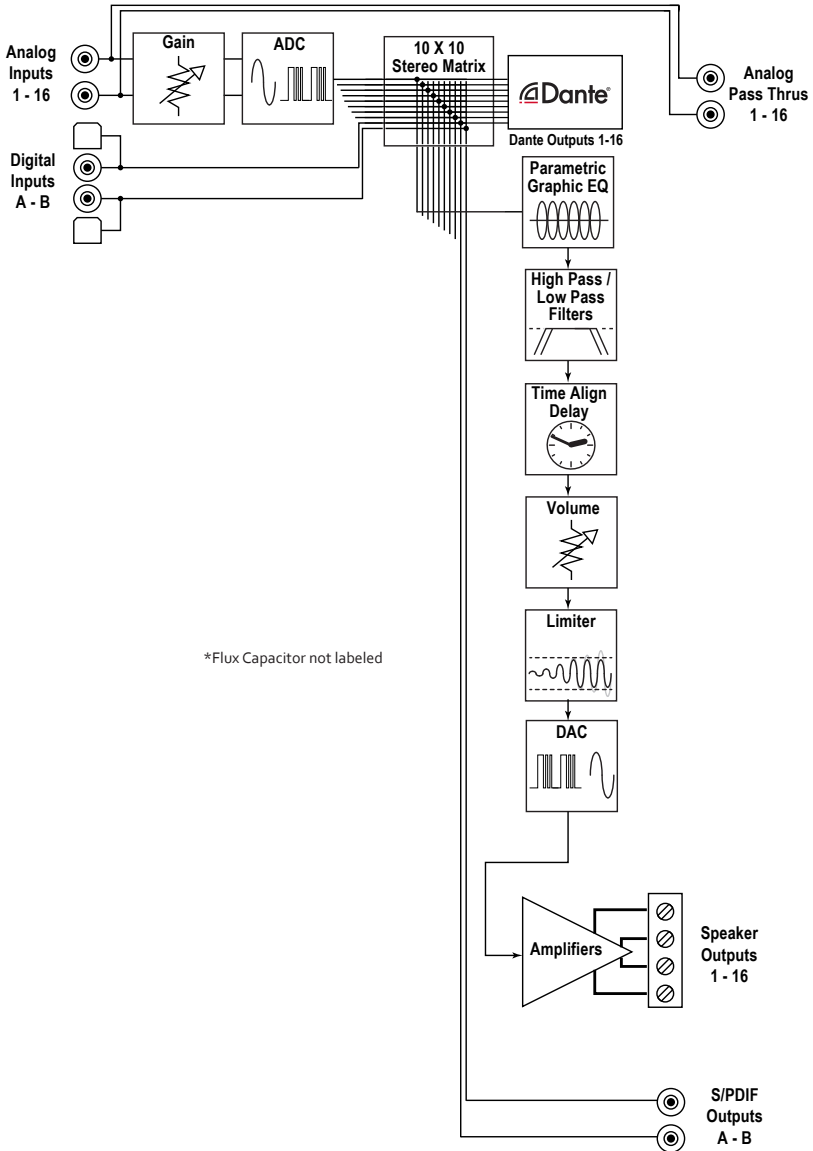

THE DIRECTOR™

Model M6800D

Installation Manual

# M6800D Specifications

## Output Power

Per Channel ..... 100 Watts @ 8 Ohm, 200 Watts @ 4 Ohm

Bridged Mono..... 400 Watts @ 8 Ohm

Signal to Noise Ratio ..... > 95 (A wtd, ref full output)

Crosstalk ..... > 80 dB @ 1 kHz

Damping Factor ..... > 300

Gain ..... 30 dB

Analog Input Sensitivity ..... 1 Vrms for full output, level at maximum

DAC Specifications ..... 32 – 96 kHz sample rate, 16/24 bit depth

## AC Power Requirements

Standby ..... <2 Watts

Idle ..... 53 Watts

1/8th power (loud listening level) ..... 330 Watts

Full Power (20 A residential service limited) ..... 2400 Watts

## BTU/hr Output

Standby ..... 6.8 BTU/hr

Idle ..... 180 BTU/hr

1/8 power (loud listening level) ..... 460 BTU/hr

Full Power ..... 2124 BTU/hr

## Dimensions

Height ..... 3.5" (2U)

Width (ears on) ..... 19.0"

Width (ears off) ..... 17.0"

Depth ..... 15.5"

Weight ..... 21 lbs

## Network Settings

Default IP Address ..... **192.168.0.249**

*Please note: Because of AudioControl's bold and daring quest to push back the frontiers of audio perfection, all specifications are subject to change without notice, and at any time, including (and not limited to) lunchtime, teatime, or when our engineers run around the factory shouting "Eureka!"*

**AudioControl®**

Making Good Sound Great™

---

## What to do if you need service

If the unit needs service, then please contact AudioControl, either by e-mail or phone. We will verify if there is anything wrong in the system that you can correct yourself, or if it needs to be sent back to our factory.

Please include the following items when returning the unit:

1. A copy of your proof of purchase. No originals please. We cannot guarantee returning them to you.
2. A brief explanation of the trouble you are having with the unit. (You'd be surprised how many people forget this.) If you can supply a really detailed description of the problem, this would be so much better, and our service technicians may add you to their Christmas Card list. Please include any notes about the system and other components you are using. Is it an intermittent problem that only occurs on the first full moon of Spring?
3. A return street address. (No PO Boxes, please).
4. A daytime phone number in case our technicians have a question about the problem you are having, or if they are just feeling lonely.
5. Package the unit in the original packaging if you still have it. Use great care and plenty of good packing materials to protect the unit and prevent it from moving about inside the box. Do not use loose materials like packing peanuts or real peanuts.

You are responsible for the freight charges to us, but we'll pay the return freight back as long as the unit is under warranty. We match whatever shipping method you use to send it to us, so if you return the unit overnight freight, we send it back overnight. We recommend United Parcel Service (UPS) for most shipments.

Please do not return the unit to AudioControl if you have not received an RMA number from our masterful customer support team.

Phone 425-775-8461

[techsupport@audiocontrolpro.com](mailto:techsupport@audiocontrolpro.com)

[support.audiocontrolpro.com](http://support.audiocontrolpro.com)

[www.audiocontrolpro.com/contact-us](http://www.audiocontrolpro.com/contact-us)

---

THE DIRECTOR™

Model M6800D

Installation Manual

# The Warranty

In just the same way as being covered in honey and thrown into a dark pit full of hungry woodchucks, people are scared of warranties. Lots of fine print. Months of waiting around. Well, fear no more. This warranty is designed to make you rave about AudioControl. It's a warranty that looks out for you and your client, plus helps you resist the temptation to have your friend Sparky, who's "good with electronics," try to repair your AudioControl product. So go ahead, grab a cup of tea, and carefully read through this warranty.

Our warranty has conditional conditions! "Conditional" doesn't mean anything ominous. The Federal Trade Commission tells all manufacturers to use the term to indicate that certain conditions have to be met before they'll honor the warranty. If you meet all of these conditions, AudioControl will, at its discretion, perform warranty service on any AudioControl products that exhibit defects in materials and/or workmanship during the warranty on your product for five (5) years from the date you bought it, and we will fix or replace it, at our option, during that time.

## Here are the conditional conditions:

1. You need to hold on to your sales receipt! All warranty service requires original sales receipt documentation. The warranty only applies to the original purchaser from an authorized AudioControl dealer. Note: Products purchased from unauthorized dealers are not covered under warranty.
2. If an authorized AudioControl dealer installs your AudioControl product, the warranty is five years, otherwise the warranty is limited to one year.
3. Our warranty covers AudioControl products that have been installed according to the instructions in the installation manual.
4. You cannot let anybody who isn't: (A) the AudioControl factory; or (B) somebody authorized in writing by AudioControl service your AudioControl product. If anyone other than (A), or (B) messes with your AudioControl product, the warranty is void.
5. The warranty is void if the serial number is altered, defaced or removed, or if your product has been used improperly. Now that may sound like a big loophole, but here is what we mean by this: Unwarranted abuse is: (A) physical damage (don't use your product to level your dining room table); (B) improper connections (120 volts into the RCA jacks can fry the poor thing); (C) sadistic things! This is the best product we know how to build, but for example if you mount it to the front bumper of your car, drop it over the Niagara Falls or use it for Clay Pigeon shooting practice, something will go wrong.

Assuming you conform to 1 through 5, and it really isn't all that hard to do, we will have you send your product to us for warranty service.

## Legalease Section

This is the only warranty issued by AudioControl. This warranty gives you specific legal rights, and you may also have rights that vary from state to state. Promises of how well your AudioControl product will work are not implied by this warranty. Other than what we've said we'll do in this warranty, we have no obligation, express or implied. We make no warranty of merchantability or fitness for any particular purpose. Also neither we nor anyone else who has been involved in the development or manufacture of the unit will have any liability of any incidental, consequential, special or punitive damages, including but not limited to any lost profits or damage to other parts of your system by hooking up to the unit (whether the claim is one for breach of warranty, negligence of other tort, or any other kind of claim). Some states do not allow limitations of consequential damages.





# The Dante Boogie

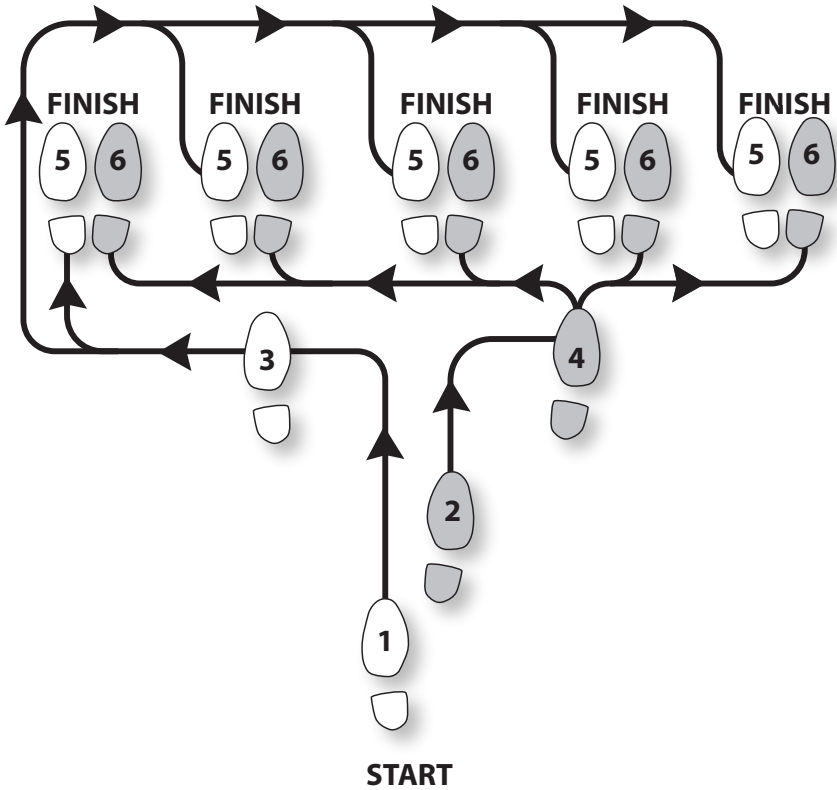

Other common names for this dance:

- Dante Boogie Nights
- Dante 2 Electric Boogaloo
- Dante Inferno